



# Iranian UAVs in Ukraine: A Visual Comparison



This product provides a visual comparison of UAVs used by Russian forces in Ukraine and Iranian UAVs used to attack U.S. and partner interests in the Middle East. Photos of UAV debris and components from Ukraine are consistent with systems showcased at military expos and other venues in the Middle East. This analysis confirms Russia's use of various Iranian lethal UAVs in its war in Ukraine.



For more information about the Defense Intelligence Agency and to view this report, visit DIA's website at [www.dia.mil](http://www.dia.mil)

For media and public inquiries about this report, contact DIA Public Affairs at [DIA-PAO@dod.iis.mil](mailto:DIA-PAO@dod.iis.mil)

Information cutoff date: 27 October 2022

Cover Image: An Iranian-origin UAV is seen flying over Kyiv, Ukraine during an attack on 17 October 2022.

Image Source: EPA Images

DIA\_F\_24L1L\_G

**This report contains copyrighted material. Copying and disseminating the contents are prohibited without the permission of the copyright owners. Images and other previously published material featured or referenced in this publication are attributed to their source.**



### *Shahed-136 (Geran-2) One-Way Attack UAV Comparison*

The Iranian-origin Shahed-136, renamed Geran-2 by the Russians, has a distinctive shape, with a delta-wing body and vertical stabilizers extending above and below the body, as displayed in Iranian press and military expos. Iran used Shahed-136 UAVs in the 2021 attack against the merchant vessel *Mercer Street* and has also transferred this system to the Huthis in Yemen. The Huthis have not used this system in an attack to date, but have displayed it publicly. The images circulating in open press of UAVs in Ukraine clearly show the features of the Shahed-136's delta-wing body and vertical stabilizers.<sup>123</sup>



Underside of a Shahed-136 (Geran-2) spotted over Kyiv, Ukraine, October 2022



Shahed-136 (Geran-2) spotted over Kyiv, Ukraine, moments before impact, October 2022

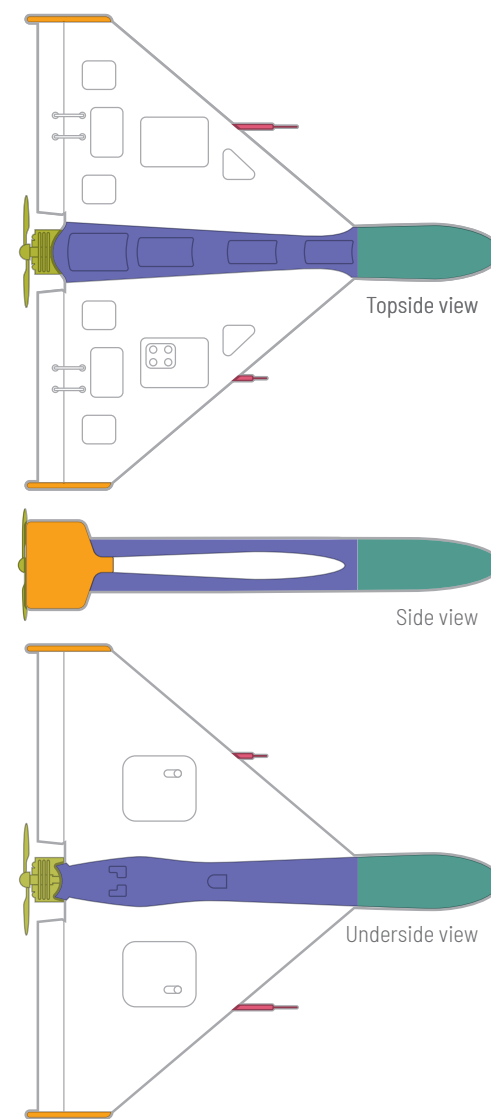

**Selected points of comparison:**

Engine Wing Stabilizer Air Data Collection Fuselage Nose Cone

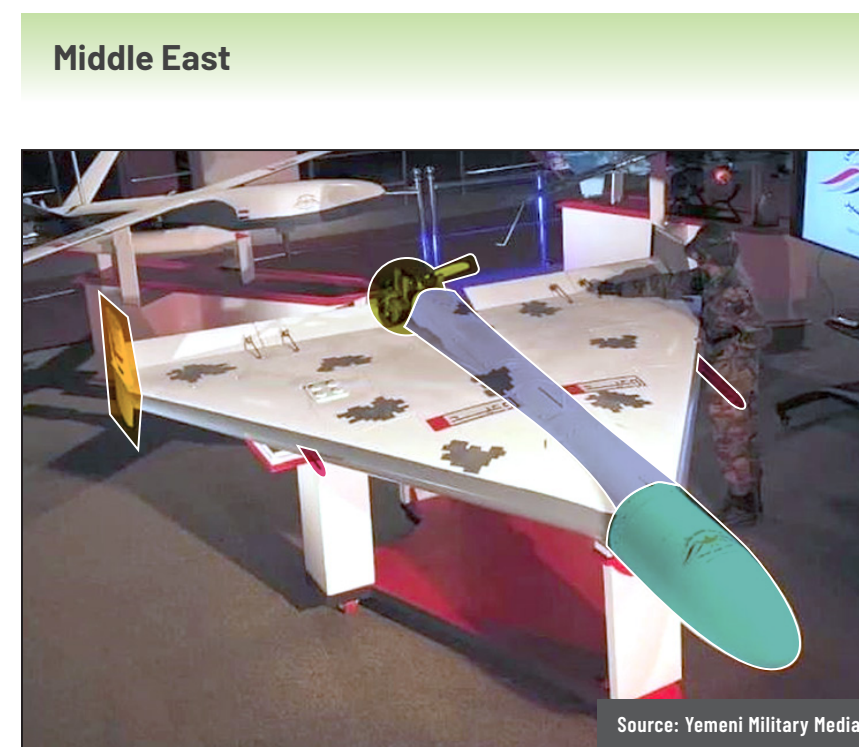

Shahed-136 displayed by the Huthis in Yemen

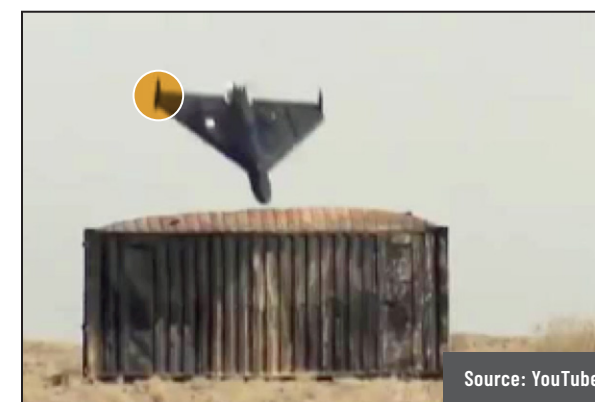

Shahed-136 from an Iranian video of military exercises in Iran, April 2021



### Shahed-136 (Geran-2) Wing Stabilizer

Shahed-136 (Geran-2) wing stabilizers recovered in Ukraine are consistent with the size, shape, and markings of the Shahed-136 wing stabilizers observed or recovered in the Middle East.<sup>45</sup>

Ukraine



Shahed-136 (Geran-2) wing stabilizer recovered in Ukraine, October 2022

Middle East

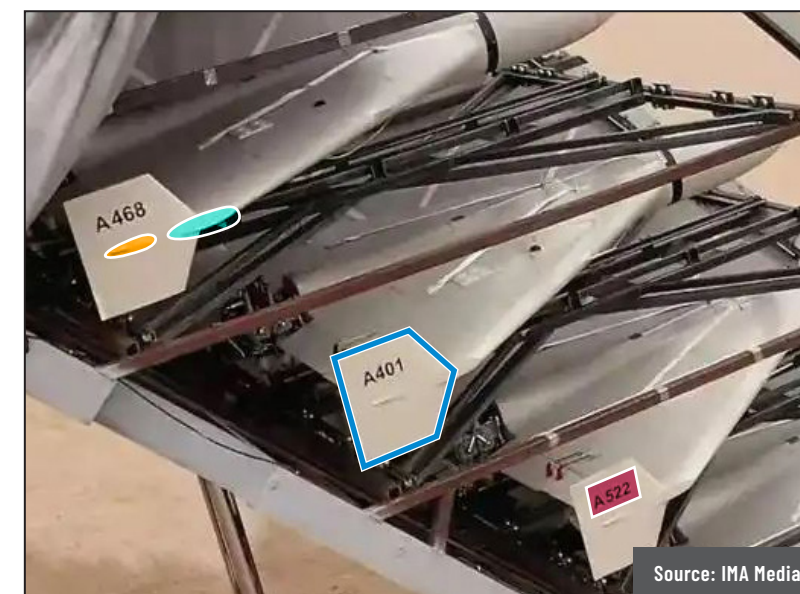

Shahed-136 UAVs preparing for launch from truck platform during IRGC Aerospace Force exercise in Iran, December 2021

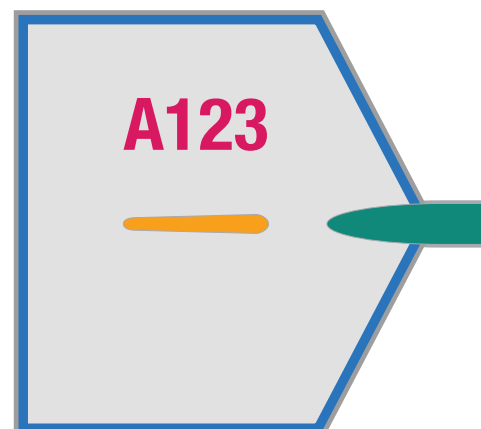

Selected points of comparison:

Stabilizer Shape

Serial Number

Winglet

Edge of Delta Wing



Shahed-136 (Geran-2) wing stabilizer recovered in Ukraine, September 2022

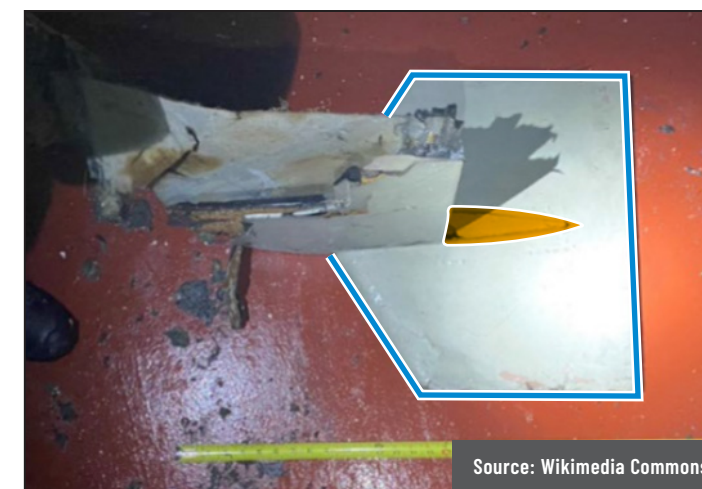

Shahed-136 wing stabilizer recovered from the attack on the merchant vessel Mercer Street, July 2021



### *Shahed-136 (Geran-2) Engine*

Shahed-136 (Geran-2) engines recovered in Ukraine appear to be Iranian produced MD-550 engines, the same engine model used in the Shahed-136.<sup>6</sup>

**Ukraine**



Source: Ukrainska Pravda

Shahed-136 (Geran-2) engine recovered in Ukraine, October 2022

**Middle East**

**Selected points  
of comparison:**

- Ring Gear
- Starter
- Exhaust
- Heat Sink and  
Ignition Components



Source: Iranian Military Forum

MAD0 550 engine displayed at the Iranian National Aerospace Exhibition, October 2014



### Shahed-131 (Geran-1) One-Way Attack UAV Comparison

The Iranian-origin Shahed-131, renamed Geran-1 by the Russians, has a delta-wing body shape similar to the Shahed-136 (Geran-2), but the vertical stabilizers extend only above the body. Recovered components in Ukraine and the Middle East appear to be very similar; some components even fractured in the same manner after impact.<sup>78</sup>

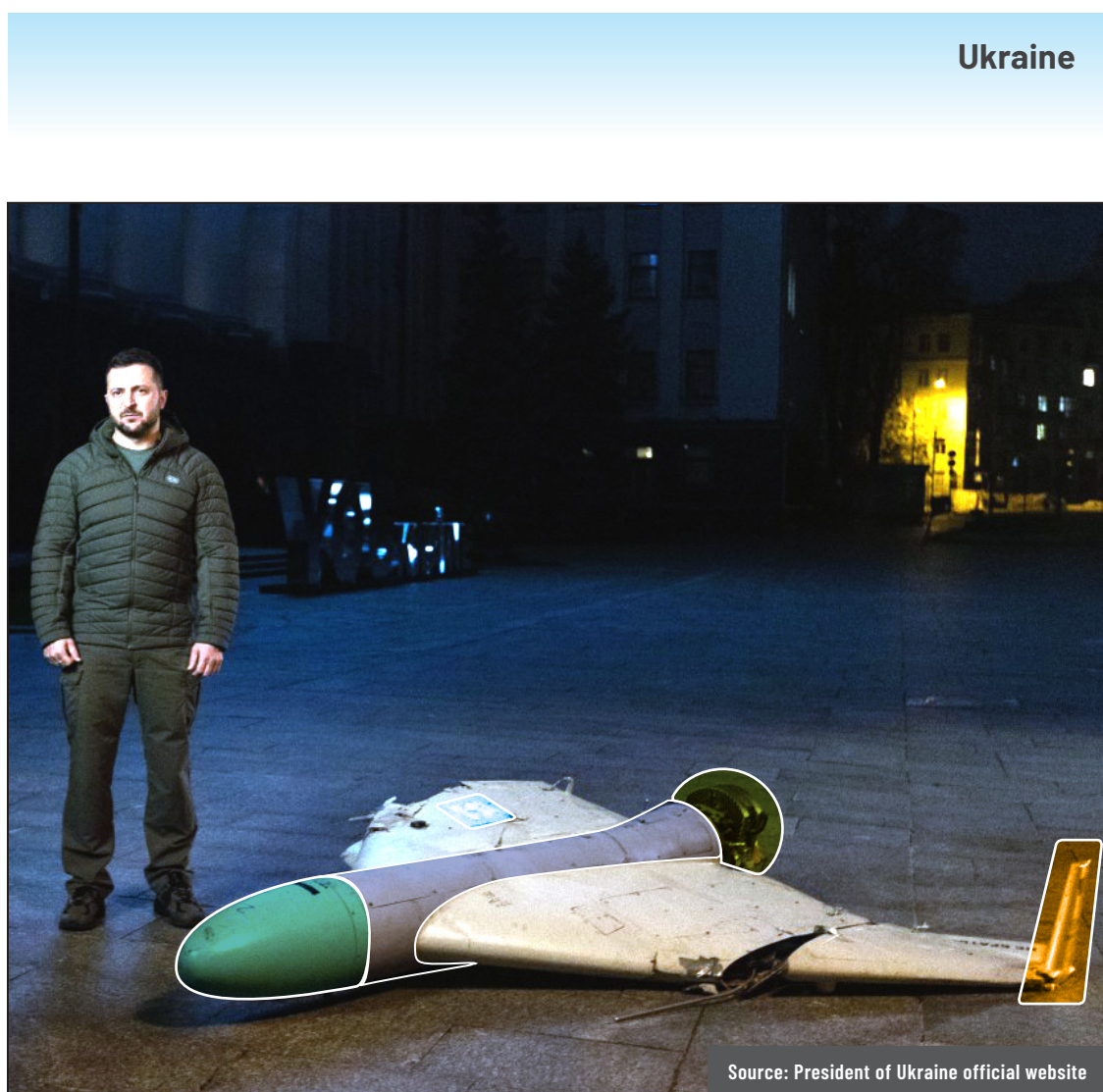

Source: President of Ukraine official website

Ukrainian President Zelenskyy showcased a Shahed-131 (Geran-1) recovered in Ukraine, 27 October 2022



Source: US Government

Shahed-131 recovered in the Middle East

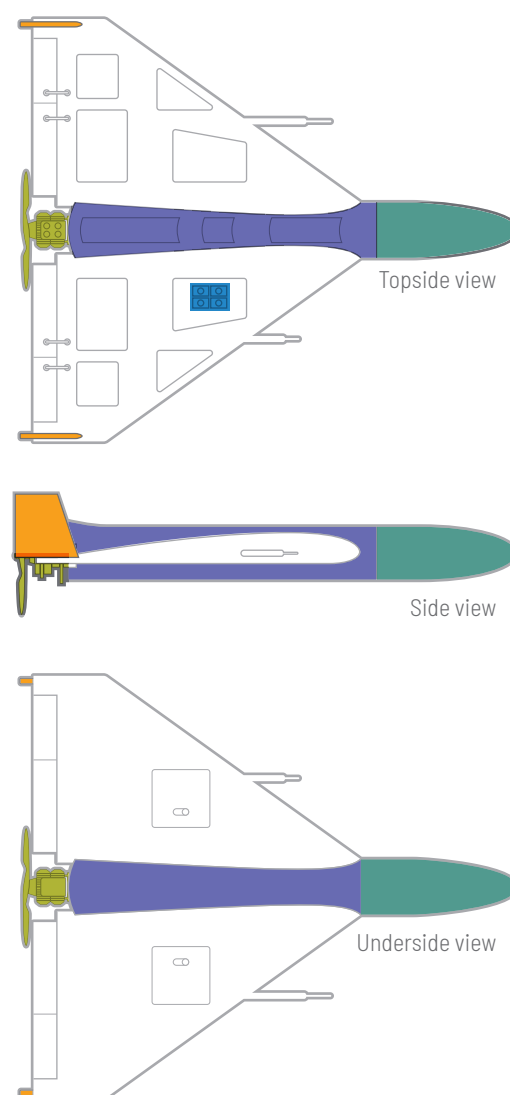









**Selected points of comparison:**

Engine Wing Stabilizer Fuselage Nose Cone Antenna Array



### Recovered Shahed-131 (Geran-1) Components

Shahed-131 (Geran-1) UAV components recovered from debris in Ukraine are consistent with Shahed-131 components recovered in Iraq in 2022.<sup>9</sup>

Ukraine		Middle East
<b>Similar components:</b>		
 <p style="text-align: right; font-size: small;">Source: Ukrainian War Crimes Prosecutors</p>	<p>Rotary Engine</p> <p>Wing Stabilizer</p> <p>Compartment Cover</p> <p>Engine Throttle Body</p> <p>Relay Board</p> <p>Processing Module Case Cover</p> <p>Processing Module Case</p>	      
	 <p style="text-align: right; font-size: small;">Source: US Government</p>	

Recovered in Kyiv, Ukraine, October 2022

Recovered in Iraq, September 2022



### Recovered Shahed-131 (Geran-1) Engine

This Shahed-131 (Geran-1) engine recovered in Ukraine is consistent with the engine of a Shahed-131 UAV recovered in Iraq.<sup>10</sup>

#### Ukraine



Recovered in Ukraine, October 2022

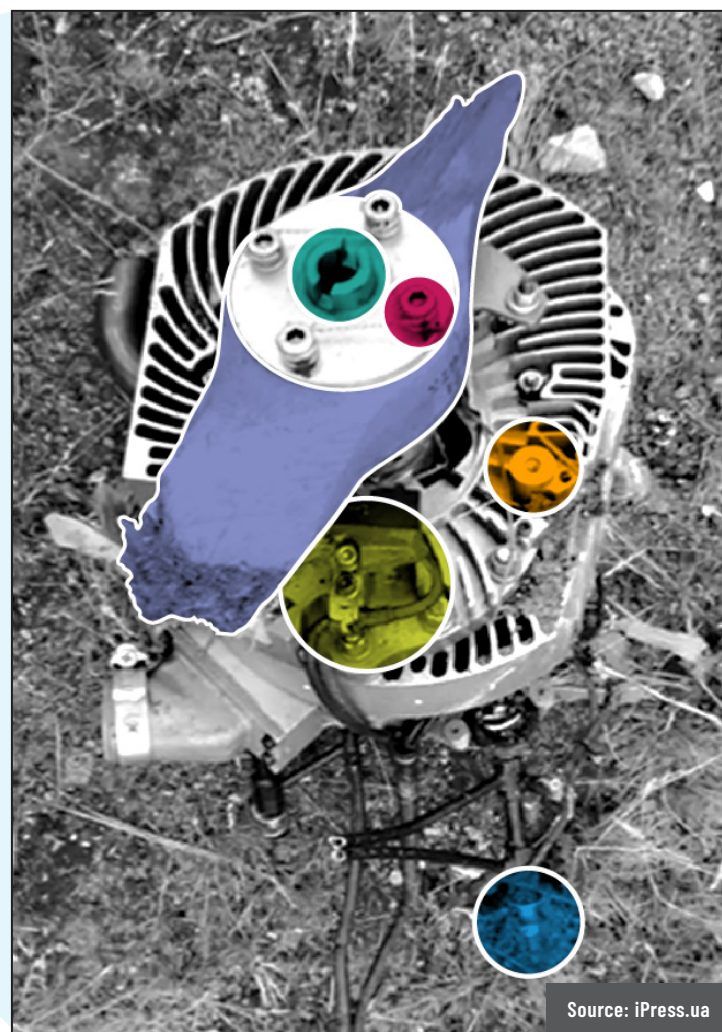

#### Middle East

Selected points of comparison:

- Wooden Propeller
- Crank Shaft
- Hex Screw
- Distinctive Housing Feature
- Ignition Component
- Engine Mount

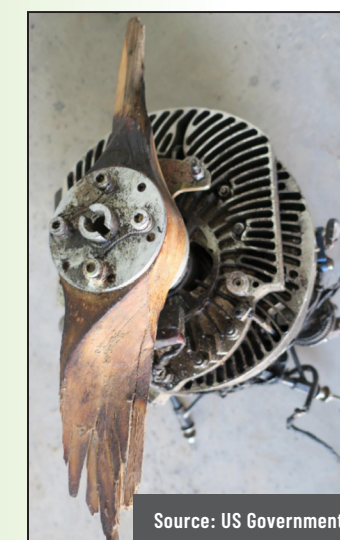
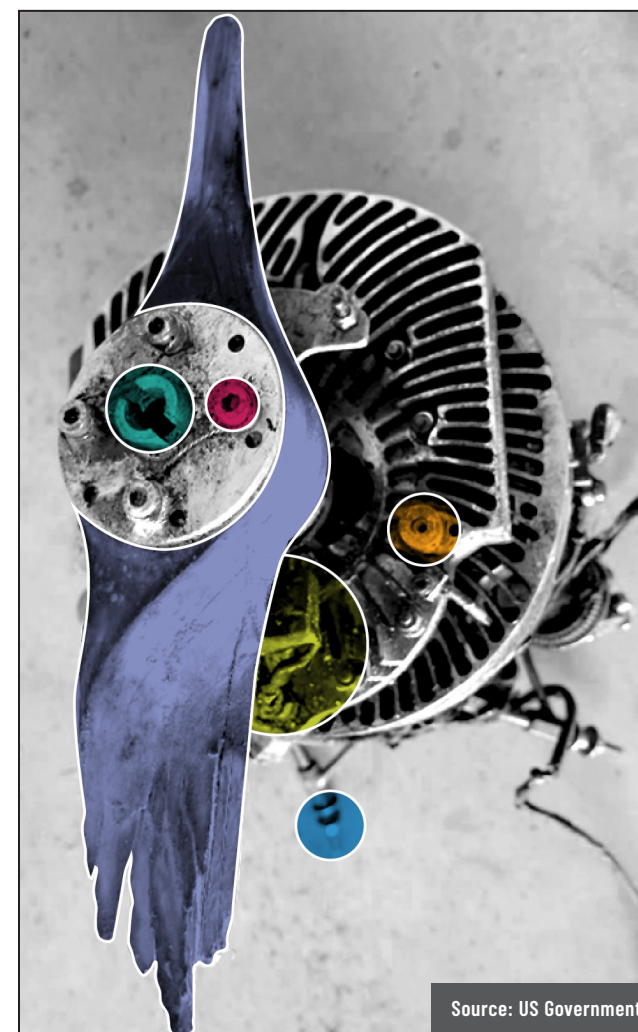

Recovered in Iraq, September 2022





### Mohajer 6 Multirole UAV Comparison

The Iranian-origin Mohajer 6 has been displayed publicly in Iran and Iraq, and can be easily identified by its distinctive tail, as well as the attached surveillance equipment and guided munitions. In October, Ukraine captured a mostly intact Mohajer 6 from the Black Sea, and it appears to be indistinguishable from the Mohajer 6 systems photographed in Iran and Iraq. Components recovered from the wreckage display very similar markings to those observed in Iran. <sup>11 12 13</sup>

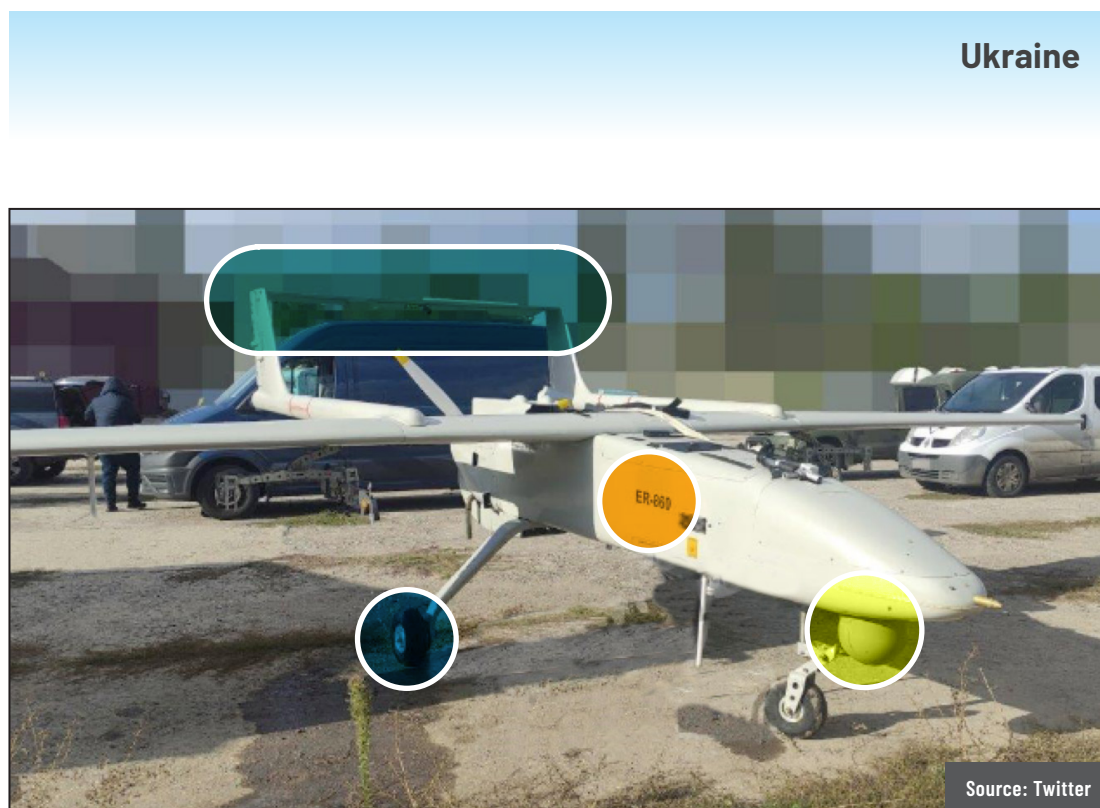

Mohajer 6 recovered from the Black Sea, October 2022



Mohajer 6 displayed in Iran, February 2018

- Selected points of comparison:**
- Horizontal Stabilizer
  - Serial Number
  - Landing Gear Wheel
  - Surveillance Equipment

Guided munition recovered from Mohajer 6, October 2022

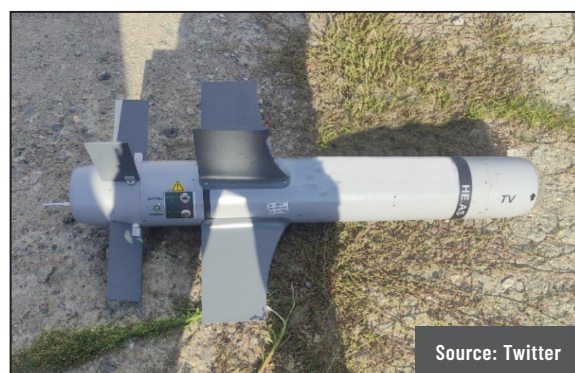

Iranian guided munition displayed at a military expo, August 2022





## DEFENSE INTELLIGENCE

### Iranian UAVs in Ukraine: A Visual Comparison

#### Source Endnotes

<sup>1</sup> ARTICLE, THE DRIVE; THOMAS NEWDICK, TYLER ROGOWAY; 13 SEP 2022; RUSSIA HAS BEGUN USING IRANIAN KAMIKAZE DRONES ON UKRAINE; [HTTPS://WWW.THEDRIVE.COM/THE-WAR-ZONE/RUSSIA-HAS-BEGUN-USING-IRANIAN-KAMIKAZE-DRONES-ON-UKRAINE](https://www.thedrive.com/the-war-zone/russia-has-begun-using-iranian-kamikaze-drones-on-ukraine).

<sup>2</sup> ARTICLE, ORYX; MARCH 2021; HOUSHI REBELS UNVEIL HOST OF WEAPONRY; URL: [HTTPS://WWW.ORYXSPIOENKOP.COM/2021/03/HOUSHI-REBELS-UNVEIL-HOST-OF-WEAPONRY.HTML](https://www.oryxspioenkop.com/2021/03/houthi-rebels-unveil-host-of-weaponry.html).

<sup>3</sup> UNITED STATES INSTITUTE OF PEACE - THE IRAN PRIMER; 06 AUG 2021; CENTCOM: IRAN BEHIND DRONE ATTACK ON TANKER; URL: [HTTPS://IRANPRIMER.USIP.ORG/BLOG/2021/AUG/10/CENTCOM-IRAN-BEHIND-DRONE-ATTACK-TANKER](https://iranprimer.usip.org/blog/2021/aug/10/centcom-iran-behind-drone-attack-tanker).

<sup>4</sup> ARTICLE, MEHR NEWS; APRIL 2022; TITLE UNKNOWN.

<sup>5</sup> UNITED STATES INSTITUTE OF PEACE - THE IRAN PRIMER; 06 AUG 2021; CENTCOM: IRAN BEHIND DRONE ATTACK ON TANKER; URL: [HTTPS://IRANPRIMER.USIP.ORG/BLOG/2021/AUG/10/CENTCOM-IRAN-BEHIND-DRONE-ATTACK-TANKER](https://iranprimer.usip.org/blog/2021/aug/10/centcom-iran-behind-drone-attack-tanker).

<sup>6</sup> ARTICLE, USKOWI ON IRAN; 25 NOV 2014; TAKEAWAYS FROM IRANIAN NATIONAL AEROSPACE EXHIBITION 2014; URL: [HTTPS://WWW.USKOWIIRAN.COM/2014/11/TAKEAWAYS-FROM-IRANIAN-NATIONAL-2014](https://www.uskowiiran.com/2014/11/takeaways-from-iranian-national-2014).

<sup>7</sup> PRESS RELEASE, UKRAINIAN GOVERNMENT; 27 OCT 2022; TODAY WE REMEMBER THE EXPULSION OF THE NAZIS, APPROACHING THE EXPULSION OF THE RASHISTS - ADDRESS BY THE PRESIDENT OF UKRAINE; URL: [HTTPS://WWW.PRESIDENT.GOV.UA/EN/NEWS/SOGODNI-MI-ZGADUYEMO-VIGNNNY-NACISTIV-NABLIZHAYUCHI-VIGNAN-78753](https://www.president.gov.ua/en/news/sogodni-mi-zgaduyemo-vignnny-nacistiv-nablizhayuchi-vignan-78753).

<sup>8</sup> PRESS RELEASE, UKRAINIAN GOVERNMENT; 13 OCT 2022; PROSECUTORS, TOGETHER WITH REPRESENTATIVES OF THE INTERNATIONAL CRIMINAL COURT, RECORD ANOTHER CRIME OF THE RUSSIAN MILITARY - AN ATTACK ON THE ENERGY INFRASTRUCTURE OF THE KYIV REGION; URL: [HTTPS://GP.GOV.&#65279;UA/UA/POSTS/PROKURORI-SPILNO-Z-PREDSTAVNIKAMI-MKS-FIKSUYUT-CERGOVII-ZLOCIN-VIISKOVIX-RF-ATAKU-NA-ENERGETIC-NU-INFRASTRUKTURU-KIYIVSHHINI](https://gp.gov.ua/ua/posts/prokurori-spilno-z-predstavnikami-mks-fiksuyut-cergovii-zlocin-viiskovix-rf-ataku-na-energetic-nu-infrastrukturu-kiyivshhini).

<sup>9</sup> PRESS RELEASE, UKRAINIAN GOVERNMENT; 13 OCT 2022; (U) PROSECUTORS, TOGETHER WITH REPRESENTATIVES OF THE INTERNATIONAL CRIMINAL COURT, RECORD ANOTHER CRIME OF THE RUSSIAN MILITARY - AN ATTACK ON THE ENERGY INFRASTRUCTURE OF THE KYIV REGION; URL: [HTTPS://GP.GOV.&#65279;UA/UA/POSTS/PROKURORI-SPILNO-Z-PREDSTAVNIKAMI-MKS-FIKSUYUT-CERGOVII-ZLOCIN-VIISKOVIX-RF-ATAKU-NA-ENERGETIC-NU-INFRASTRUKTURU-KIYIVSHHINI](https://gp.gov.ua/ua/posts/prokurori-spilno-z-predstavnikami-mks-fiksuyut-cergovii-zlocin-viiskovix-rf-ataku-na-energetic-nu-infrastrukturu-kiyivshhini).

<sup>10</sup> ARTICLE, IPRESS.UA; 22 OCT 2022; (U) SUROVIKIN WILL TRY TO PARALYZE THE WORK OF THE AUTHORITIES AND MAKE THE LIVES OF CIVILIANS MISERABLE - TOM COOPER; OVERALL CLASSIFICATION IS UNCLASSIFIED; URL: [HTTP://IPRESS.UA/ARTICLES/SUROVIKIN\\_NAMAGATYMETSYA\\_PARALIZUVATY\\_ROBOTU\\_VLADY\\_I\\_ZROBYTY\\_ZHYTTYA\\_TSYVILNYH\\_ZHALYUGIDNYM\\_TOM\\_KUPER\\_335061.&#65279;HTML](http://ipress.ua/articles/surovikin-namagatymetsya-paralizuvaty-robotu-vlady-i-zrobyty-zhyttya-tsyvilnyh-zhalyugidnym-tom-kuper-335061.&#65279;html).

<sup>11</sup> ARTICLE, JANES DEFENCE WEEKLY; JEREMY BINNIE; 13 JUL 2022; CUT-PRICE CAPABILITY: THE PROLIFERATION OF IRANIAN ATTACK UAVS.

<sup>12</sup> ARTICLE, MEHR NEWS AGENCY; 05 FEB 2018; IRAN STARTS MASS PRODUCTION OF ADVANCED DRONE MOHAJER-6; URL: [HTTPS://EN.MEHRNEWS.COM/PHOTO/131926/IRAN-STARTS-MASS-PRODUCTION-OF-ADVANCED-DRONE-MOHAJER-6](https://en.mehrnews.com/photo/131926/iran-starts-mass-production-of-advanced-drone-mohajer-6).

<sup>13</sup> ARTICLE, PAKISTAN DEFENCE; FEB 2018; IRAN STARTS MASS PRODUCTION OF MOHAJER 6 UCAV, QAEM SMART GUIDED BOMB [PIC]; URL: [HTTPS://DEFENCE.PK/PDF/THREADS/IRAN-STARTS-MASS-PRODUCTION-OF-MOHAJER-6-UCAV-QAEM-SMART-GUIDED-BOMB-PIC.542732/](https://defence.pk/pdf/threads/iran-starts-mass-production-of-mohajer-6-ucav-qaem-smart-guided-bomb-pic.542732/).



[www.dia.mil](http://www.dia.mil)